



Download Tool User Guide

Issue V4.3
Date 10-Sep-2021

Copyright © UNISOC (Shanghai) Technologies Co., Ltd. All rights reserved.

All data and information contained in or disclosed by this document is confidential and proprietary information of UNISOC (Shanghai) Technologies Co., Ltd. (hereafter referred as UNISOC) and all rights therein are expressly reserved. This document is provided for reference purpose, no license (express or implied, by estoppel or otherwise) to any intellectual property rights is granted by this document, and no express and implied warranties, including but without limitation, the implied warranties of fitness for any particular purpose, and non-infringement, as well as any performance. By accepting this material, the recipient agrees that the material and the information contained therein is to be held in confidence and in trust and will not be used, copied, reproduced in whole or in part, nor its contents revealed in any manner to others without the express written permission of UNISOC. UNISOC may make any changes at any time without prior notice. Although every reasonable effort is made to present current and accurate information, UNISOC makes no guarantees of any kind with respect to the matters addressed in this document. In no event shall UNISOC be responsible or liable, directly or indirectly, for any damage or loss caused or alleged to be caused by or in connection with the use of or reliance on any such content.

Please refer to the UNISOC Documents in the UNISOC Deliverables for the use of the Deliverables. Any loss caused by the modification, customization or use of the UNISOC Deliverables in violation of the instructions in the UNISOC Documents shall be undertaken by those who conduct so. The performance indicators, test results and parameters in the UNISOC Deliverables are all obtained in the internal development and test system of UNISOC and are only for the reference. Before using UNISOC Deliverables commercially or conducting mass production of the Deliverables, comprehensive testing and debugging in combination with its own software and hardware test environment are pre-requisite.

UNISOC (Shanghai) Technologies Co., Ltd.



About this document



Purpose

This document aims to describe how to use the download tools of UNISOC and how to conduct factory testing.

Intended audience

This document is intended primarily for technical personnel of production line testing and developers and testing personnel of UNISOC.

Symbol conventions

Symbol	Description
 NOTE	Calls attention to important information, best practices and tips. NOTE is used to address information not related to personal injury, equipment damage, and environment deterioration.
 CAUTION	Calls attention to error-prone operations. CAUTION is used to address information not related to personal injury, equipment damage, and environment deterioration.
 WARNING	Calls attention to irreversible operations. WARNING is used to address information not related to personal injury and environment deterioration.

Acronyms and abbreviations

Acronym and Abbreviation	Full Name
MMI	Man Machine Interface
PCBA	Printed Circuit Board Assembly

Revision history

Issue	Date	Description
V1.0	28-Sep-2017	This issue is the first official release.
V2.0	01-Apr-2018	Update Logo.
V2.1	25-Jul-2019	<ul style="list-style-type: none"> • Add content in FAQ. • Update some contents.
V3.0	23-Sep-2020	<ul style="list-style-type: none"> • Update the screenshot of new-version tool interface. • Add function description of some interfaces. • Add FAQ, and supplement log level configuration. • Add function description for the first entry of the mode after boot. • Add configuration description of Sparse2Raw. • Add introduction of Inroduction Flag.
V4.0	26-Jan-2021	<ul style="list-style-type: none"> • Add description of the entry method 1.4.3 Keyless triggering download mode. • Add 6 Command line download.
V4.1	01-Mar-2021	<ul style="list-style-type: none"> • Update UI interface description of 2 Tool introduction. • Update description of 8.6 Set tool Log level
V4.2	13-Apr-2021	<ul style="list-style-type: none"> • Add content in FAQ. • Add introduction of the function Download Img file.
V4.3	10-Sep-2021	<ul style="list-style-type: none"> • Modify the document name from <i>UNISOC Download User Guide</i> to <i>Download Tool User Guide</i>. • Modify the content structure, and optimize the content. <ul style="list-style-type: none"> – Delete the introduction of the function Download Img file. – Divide FAQ into 7 Interface error message and 8 FAQ and supplementary information.

Keywords

FactoryDownload, UpgradeDownload, ResearchDownload

Contents

1 Overview	1
1.1 Function introduction	1
1.2 Runtime environment.....	1
1.2.1 Hardware requirement	1
1.2.2 Software requirement.....	2
1.3 Download environment setup.....	2
1.4 Entry methods of download mode.....	3
1.4.1 Pin pull-down or pull-up.....	3
1.4.2 Key triggering.....	3
1.4.3 Keyless triggering	4
1.5 Watchdog.....	4
2 Tool introduction	5
2.1 Main interface.....	5
2.2 Tool bar.....	6
2.3 Status bar.....	6
3 FactoryDownload user guide.....	9
3.1 Download settings	9
3.1.1 Main Page.....	9
3.1.2 Options.....	10
3.1.3 Multi Languages.....	12
3.1.4 LCD Configure.....	12
3.1.5 Customization.....	12
3.2 Operating instruction.....	13
3.2.1 Load a file	13
3.2.2 Set download parameters	13
3.2.3 Start download.....	13
3.2.4 Complete download	14
3.2.5 Exit download.....	15
4 UpgradeDownload user guide	16
4.1 Download settings	16
4.1.1 Main Page.....	16
4.1.2 Options.....	17
4.1.3 Multi Languages.....	18
4.1.4 LCD Configure.....	18
4.1.5 Customization.....	18
4.2 Operating instruction.....	19
4.2.1 Load a file	19
4.2.2 Set download parameters	19

4.2.3 Start download.....	20
4.2.4 Complete download.....	20
4.2.5 Exit download.....	21
5 ResearchDownload user guide	22
5.1 Download settings	22
5.1.1 Main Page.....	22
5.1.2 Options.....	23
5.1.3 Backup.....	25
5.1.4 Flash Operations.....	27
5.1.5 Multi Languages.....	29
5.1.6 LCD Configure.....	29
5.1.7 MCP Type.....	29
5.1.8 Vol-Freq Tuning.....	30
5.1.9 Uart Port Switch.....	31
5.2 Operating instruction.....	32
5.2.1 Load a file.....	32
5.2.2 Set download parameters.....	32
5.2.3 Start download.....	33
5.2.4 Complete download.....	33
5.2.5 Exit download.....	34
6 Command line download	35
6.1 Parameter format	35
6.2 Download example.....	35
7 Interface error message analysis and solution	37
7.1 [DL1150] Incompatible partition.....	37
7.2 [UB1142] Wait input time out.....	37
7.3 [DL1138] Image size is over its partition.....	37
7.4 [PS2262] User cancel.....	38
7.5 [UB1254] Software has not supported this feature.....	38
7.6 [PS2257] Uart send error.....	38
7.7 [UB1132] Operation failed.....	39
7.8 [SW2020] NV data read in phone is crashed.....	39
7.9 [SW2021] NV data in nvitem.bin is crashed.....	39
8 FAQ and supplementary information	40
8.1 Unrecognize the port	40
8.2 Fail to capture the port after modifying the port name	40
8.3 Local file has a .flag suffix after decompressing Pac.....	40
8.4 Modify required or optional attributes of files in the partition list.....	41
8.5 Record ID information of the module.....	41
8.6 Set tool Log level.....	42

8.7 Check MCP (DDR or EMMC).....	42
8.8 Set password for download tool.....	43
8.9 Inroduction Flag function.....	44
8.10 Set the writing length of FactoryDownload SN.....	44
8.11 Set the prefix of the SN written in by FactoryDownload.....	44
8.12 Set the entry mode of the first booting after FactoryDownload download.....	45
8.13 Configure Sparse2Raw in FactoryDownload.ini.....	46
8.14 Upgrade software using UpgradeDownload.....	46
8.15 Packet using ResearchDownload.....	46
8.16 Erase Flash using ResearchDownload.....	47
8.17 Prompt message (Size is too large) occurs when ResearchDownload reads FixNV write-back.....	48
8.18 Set ResearchDownload Debug Level.....	48

List of figures

Figure 1-1 Download environment of the PCBA stage of production line	2
Figure 2-1 Main interface of FactoryDownload	5
Figure 2-2 Status bar.....	7
Figure 2-3 Successful download with mobile phone connected	7
Figure 2-4 Successful download with mobile phone disconnected	8
Figure 2-5 Failed download	8
Figure 3-1 FactoryDownload Main Page	9
Figure 3-2 FactoryDownload Options.....	11
Figure 3-3 FactoryDownload Customization.....	12
Figure 3-4 FactoryDownload in download status	14
Figure 3-5 FactoryDownload Input SN input box.....	14
Figure 3-6 Suspend FactoryDownload download.....	14
Figure 3-7 FactoryDownload download completed.....	14
Figure 3-8 FactoryDownload waits for download again	14
Figure 4-1 UpgradeDownload Main Page.....	16
Figure 4-2 UpgradeDownload Options	17
Figure 4-3 UpgradeDownload Customization	19
Figure 4-4 UpgradeDownload in download status	20
Figure 4-5 UpgradeDownload download completed.....	20
Figure 4-6 UpgradeDownload waits for download again.....	20
Figure 5-1 ResearchDownload Main Page.....	22
Figure 5-2 ResearchDownload Options	24
Figure 5-3 ResearchDownload Backup.....	26
Figure 5-4 ResearchDownload Flash Operations.....	27
Figure 5-5 ResearchDownload MCP Type	30
Figure 5-6 ResearchDownload Vol-Freq Tuning	31
Figure 5-7 ResearchDownload Uart Port Switch.....	32
Figure 5-8 ResearchDownload in download status	33

Figure 5-9 ResearchDownload download completed	33
Figure 5-10 ResearchDownload waits for download again	33
Figure 6-1 Successful CmdDloader download	36
Figure 6-2 Failed CmdDloader download	36
Figure 8-1 Enter password	43
Figure 8-2 Reset password	44
Figure 8-3 Packet setting.....	47
Figure 8-4 Packeting complete prompt	47
Figure 8-5 Erase Memory using ResearchDownload.....	48

List of tables

Table 1-1 Hardware requirement	1
Table 1-2 Software requirement.....	2
Table 1-3 Hardware resource.....	3
Table 2-1 Description of the main interface.....	5
Table 2-2 Description of Tool bar	6
Table 2-3 Description of Status bar.....	7
Table 3-1 Description of FactoryDownload Main Page.....	9
Table 3-2 Description of FactoryDownload Options	11
Table 4-1 Description of UpgradeDownload Main Page	17
Table 4-2 Description of UpgradeDownload Options	18
Table 5-1 Description of ResearchDownload Main Page	23
Table 5-2 Description of ResearchDownload Options.....	24
Table 5-3 Read Flash configuration item.....	27
Table 5-4 Erase Flash configuration item	28
Table 5-5 Write Flash configuration item	28

1 Overview

1.1 Function introduction

Download means to write mobile software into hardware module through a download tool. The UNISOC download tools support simultaneous download of a software for multiple modules in a relatively efficient and simple way. Once the module is connected to the port correctly and the correct mode is set, the program detects it and starts the download process automatically. After downloading a software, you need to replace the module manually. Then, the program repeats the process.

UNISOC provides three download tools for different scenarios.

- FactoryDownload

This tool is commonly used for production download in Printed Circuit Board Assembly (PCBA) stage. It can erase the production parameters in production line, such as ProdNV and Fix NV partitions, while initializing PhaseCheck. It supports SN number pre-writing.

- UpgradeDownload

This tool is commonly used for software upgrade in PCBA stage or complete machine stage of a mobile phone. The calibration flag bit is checked before the upgrade, and the upgrade cannot be performed if the calibration flag bit is not set. The main feature of this tool is that it backs up NV parameters compulsively before upgrade, and does not initialize PhaseCheck and ProdNV partitions.

- ResearchDownload

The tool is commonly used for R&D debugging. It supports many functions, including Flash partition reading and writing, NV parameters, PhaseCheck and ProdNV partitions back up, and downloaded file packing. The tool does not initialize ProdNV and PhaseCheck partitions by default.

1.2 Runtime environment

1.2.1 Hardware requirement

The basic requirement of hardware is shown in [Table 1-1](#).

Table 1-1 Hardware requirement

Hardware	Basic requirement
PC	<ul style="list-style-type: none">• CPU: i5 or later versions• Internal memory: 8GB or larger
USB cable	No special requirement.
USB expansion card	USB expansion card is necessary for downloading a software for multiple modules simultaneously.

Hardware	Basic requirement
Power supply	<ul style="list-style-type: none"> • Common DC power supply requires UNISOC voltage stabilizer. • Precision DC power supply outputs stably.

1.2.2 Software requirement

The basic requirement of software is shown in [Table 1-2](#).

Table 1-2 Software requirement

Software	Version requirement
OS version	Windows7, Windows10

1.3 Download environment setup

Download using FactoryDownload or UpgradeDownload

When using FactoryDownload or UpgradeDownload to download in the PCBA stage of production line, an example of environment setup is shown in [Figure 1-1](#).

Figure 1-1 Download environment of the PCBA stage of production line

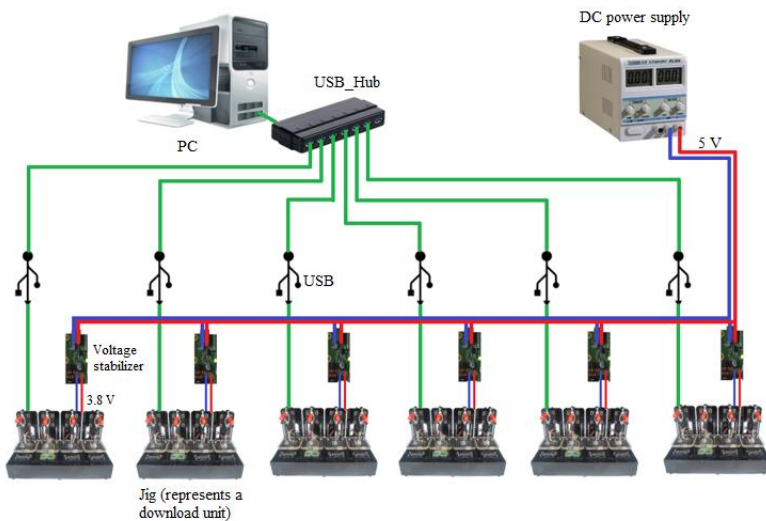







Table 1-3 Hardware resource

Device	Description
	<ul style="list-style-type: none"> PC meets the requirement of 1.2 Runtime environment. PC is connected to the testing module through a USB cable.
	USB_Hub is equipped with a powered USB Hub or a USB expansion card.
	DC power supply uses precision DC power supply or uses common DC power supply with UNISOC voltage stabilizer.
	Voltage stabilizer.
	Download fixture.

Download using ResearchDownload

ResearchDownload is not commonly used in the scenario of downloading a software simultaneously for multiple modules. Therefore, it does not need USB Hub, USB expansion card, and voltage stabilizer, and its download environment setup is very simple.

- When downloading a module through the USB cable, a USB cable is needed to connect the PC and the module directly, and a common regulated power supply or a battery is needed to supply power to the module.
- When downloading a module through the Uart port, a USB Uart board and flat cables are needed additionally.

1.4 Entry methods of download mode

1.4.1 Pin pull-down or pull-up

When Flash is not empty, the PCBA stage uses fixture to download. The module enters the download mode by detecting the pull-down or pull-up state of a specific pin when the mobile phone is powered on. It depends on the specific project to use the pin pull-down or pull-up to enter the download mode. For example, UIS8910DM pulls up the U1TXD pin. The specific method of pin pull-down or pull-up is as follows.

- Pin pull-down
 - The nBoot pin is ground-connected.
 - The U1TXD pin is connected to a 1 kΩ pull-down resistor.
- Pin pull-up: pull up the U1TXD pin.

Click  on Tool bar (such as the Tool bar of FactoryDownload) and power on the mobile phone, and wait the module to enter the download mode.

1.4.2 Key triggering

In complete machine stage, key triggering method is commonly used to enter the download mode.

- On UNISOC smartphone platforms, press and hold **Volume (KEYIN0)** and power on the mobile phone at the same time, the mobile phone enters the download mode.
- On UNISOC feature phone platforms, press and hold **KEYIN0** or **KEYOUT0** and power on the mobile phone at the same time, the mobile phone enters the download mode. Different programs may define its own triggering keys of entering the download mode.

1.4.3 Keyless triggering

Before using this function when the mobile phone is power off, assign the value of **DownloadByPoweroff** in **BMFileType.ini** to 1. When this function is enabled, connect the USB cable directly after clicking **Start Downloading** on Tool bar, and the mobile phone enters the download mode.

NOTE

- The precondition of keyless triggering is that the Flash of the mobile phone must be empty, or the previous download of the mobile phone is in Pass status.
- Failed download disables keyless triggering. Follow the methods below to solve this problem.
 - Enter the download mode forcibly through key triggering method (see [1.4.2 Key triggering](#)).
 - Refer to [1.5 Watchdog](#) to make the mobile phone reboot automatically.
 - Reboot the mobile phone forcibly.

1.5 Watchdog

The prerequisite to enable this function is that the mobile phone supports Watchdog commands (**OpenWatchDog** and **CloseWatchDog**). To enable the function, assign the value of **WatchDog field** in **BMFileType.ini** to 1. The **WatchDogTime** field is used to set the watchdog timeout. The default value is 150000 ms.

After enabling the function, the download tool sends the command **OpenWatchDog** after FDL2 starts, and send the command **CloseWatchDog** before Poweroff. If the download fails, the mobile phone performs a reboot action after the timeout of Watchdog.

NOTE

Set **WatchDogTime** according to the actual situation. It should at least exceed the whole packet download time.

2 Tool introduction

2.1 Main interface

Apart from the tool name displayed at the top-left corner the prompt message at the button-right corner, the main interfaces of FactoryDownload, UpgradeDownload and ResearchDownload are almost the same.

The main interface of FactoryDownload is taken as an example to introduce its basic operations.

Figure 2-1 Main interface of FactoryDownload

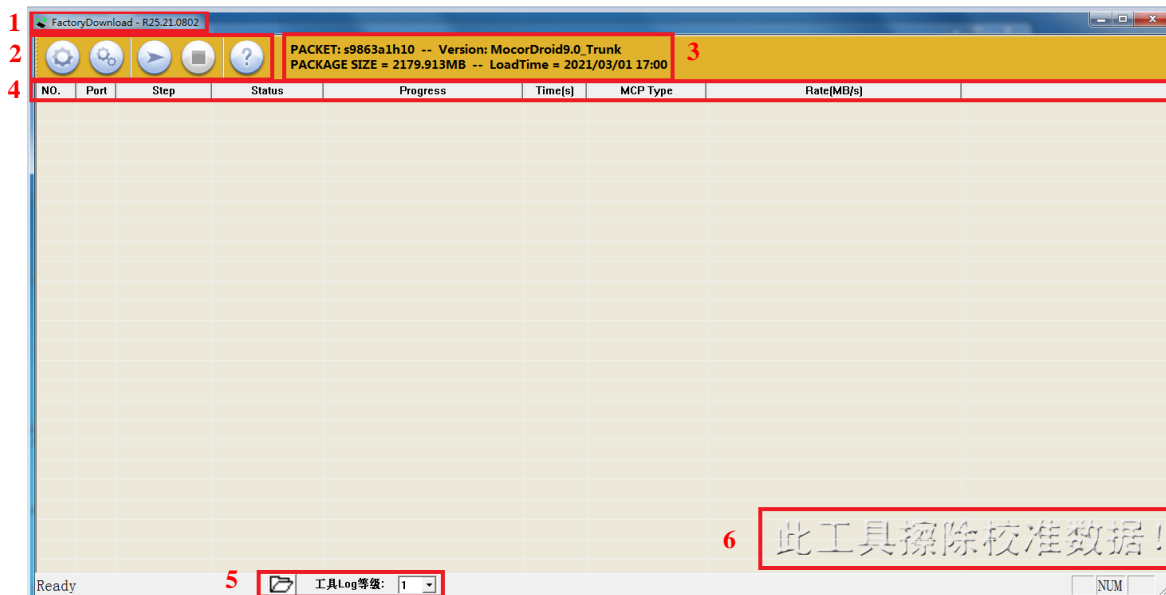







Table 2-1 Description of the main interface

No.	Item	Description
1	Title bar	It displays the name and version of the tool.
2	Tool bar	It contains Load packet , Settings , Start downloading , Stop downloading , and About buttons.
3	Packet information	It shows the name, version, size and load time of the packet.
4	Status bar	It shows status information, including the download device number, download port number, current operation file name or operation description, current operation status, download progress, download time, download rate.
5	Tool log setting	It can open the tool log path and set tool log level.

No.	Item	Description
6	Prompt message	It can be replaced through bin/rdl_bkmark.bmp file.

2.2 Tool bar

Table 2-2 Description of Tool bar

Button icon	Meaning	Description
	Load packet	This button is to select the packet and configuration file to download, where configuration file is optional. This button is disabled when the download starts, and be available when the download stops.
	Settings	This button is to set the download parameters. Click it to open the dialog box for setting. This button is disabled when the download starts, and be available when the download stops.
	Start downloading	<p>This button is to detect and open the available ports, and to prepare for the download process. There are two download modes.</p> <ul style="list-style-type: none"> • Automatic mode: The program automatically detects if there is a module connected to the port. If yes, the download process starts automatically. When the download finishes, the program automatically detects again if there is a module connected to the port. • Manual mode: The program reports the download result after the module is downloaded, and pauses. The download starts again only when you click Start. <p>This button is disabled when running the program for the first time, and you can only start the download process after setting it first.</p>
	Stop downloading	<p>This button is to stop the download process. This button is available only when you click Start and the program opens the available ports.</p> <p>In order to protect NV files, the Stop button is unavailable when entering the process to avoid clicking. In any other cases, you can click this button to stop the download process.</p> <p>Only after the download process stops can the program be exited.</p>
	About	This button is to open the tool Doc directory quickly. You can check the meaning of error message on the interface or open the User Guide.

2.3 Status bar

The Status bar is to display status information, including port status, download status and download result, as shown in [Figure 2-2](#).

Figure 2-2 Status bar

NO.	Port	Step	Status	Progress	Time(s)	MCP Type
1	4	ProdNV	Downloading...		5	—

Table 2-3 Description of Status bar

Item	Description
No	Number the downloading devices in order. If restarted, the tool binds to the port numbers according to the new connection order, and you need to pay attention to the insertion order.
Port	Available port number, and X means that this port cannot be opened.
Step	The current operation document name or operation description.
Status	The current operation status.
Progress	The progress bar. <ul style="list-style-type: none"> • Waiting means that an operation is in progress. • Passed means that the download succeeds, and the mobile phone is connected. • Ready means that the download succeeds, and the mobile phone is disconnected. • Failed means that the download fails.
Time[s]	Time of a single download. The unit is s.
MCP Type	The MCP Type (Flash size) information of the current download device.
Rate[MB/s]	Download rate. <ul style="list-style-type: none"> • Actual download: the currently downloaded data. The unit is MB. • Average rate: the current average download rate. The unit is MB/s. The actual download data determines the average rate. And the actual download data may differ from the Pac size. • Peak rate: the maximum download rate. The unit is MB/s.

- When the download succeeds, and the mobile phone is connected, the interface information is shown in [Figure 2-3](#).

Figure 2-3 Successful download with mobile phone connected

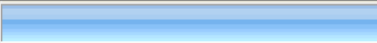
NO.	Port	Step	Status	Progress	Time(s)	MCP Type	IMEI
1	4	_POWEROFF_	Finish	Passed	17s	—	—

- When the download succeeds, and the mobile phone is disconnected, the interface information is shown in [Figure 2-4](#)

Figure 2-4 Successful download with mobile phone disconnected

NO.	Port	Step	Status	Progress	Time[s]	MCP Type	IMEI
1	4	_POWEROFF_	Unplugged	Ready	17s	—	—

- When the download fails, the interface information is shown in **Figure 2-5**.

Figure 2-5 Failed download

NO.	Port	Step	Status	Progress	Time[s]	MCP Type	IMEI
1	4	FDL	Unplugged	Failed: [PS2262]User cancel	2s	—	—

3 FactoryDownload user guide

FactoryDownload is applicable for production download in PCBA stage. The tool can initialize PhaseCheck, divide ProdNV, erase NV parameters, and pre-write SN number. It erases Running NV forcibly, and writes in Fix Nv. Therefore, you need to backup NV as needed before using this tool.

3.1 Download settings

Click  to enter the setting interface of FactoryDownload, as shown in **Figure 3-1**. The interface contains five tabs: Main Page, Options, Multi Languages, LCD Configure, and Customization.

Figure 3-1 FactoryDownload Main Page

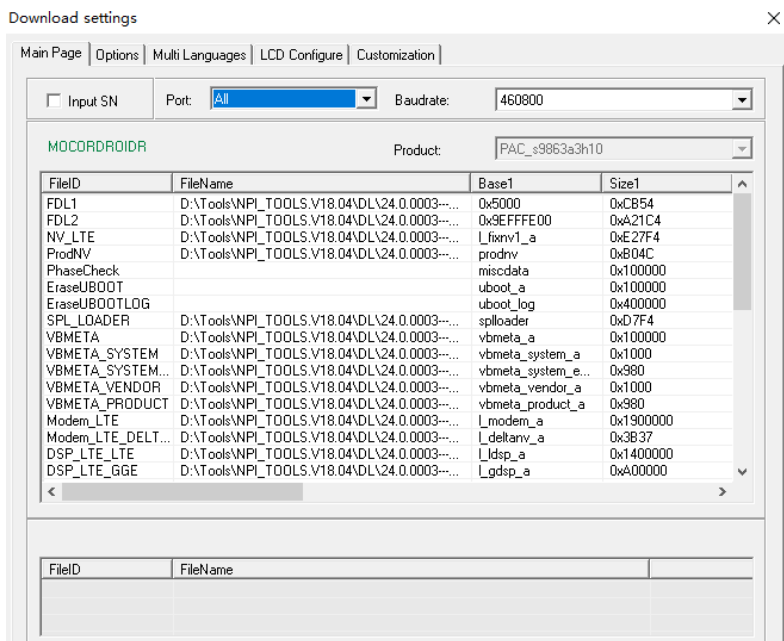

3.1.1 Main Page

As shown in **Figure 3-1**, Main Page is used to configure the port and its baud rate, and display information including downloaded file version and Product. For more details, see **Table 3-1**.

Table 3-1 Description of FactoryDownload Main Page

Item name	Description
Input SN	When this checkbox is cleared, the tool writes in SN randomly. When selected, you need to input SN.

Item name	Description
Port	Port setting. You can select a certain port to download or select All . When selecting All , the tool automatically detects available ports for downloading. A module corresponds to an available port. When downloading a software for multiple modules simultaneously, there are multiple available ports.
Baudrate	Baud rate setting. This is necessary only when downloading through Uart.
Information bar	Displays version and Product information above the file list.
Downloaded file list	<ul style="list-style-type: none">• FileID indicates the name of downloaded file.• FileName displays the path to download the file.• Base1 indicates the download address.• Size1 indicates the file size (0x0 indicates that the file size is automatically calculated by the download tool during download).

3.1.2 Options

Options interface requires the support of FDL or Uboot module. As shown in [Figure 3-2](#), only **Reset to Normal**, **PowerOff** (selected by default) and **Dump Uboot Log** can be selected. Other options can be implemented only by modifying the configurations in FactoryDownload.ini.

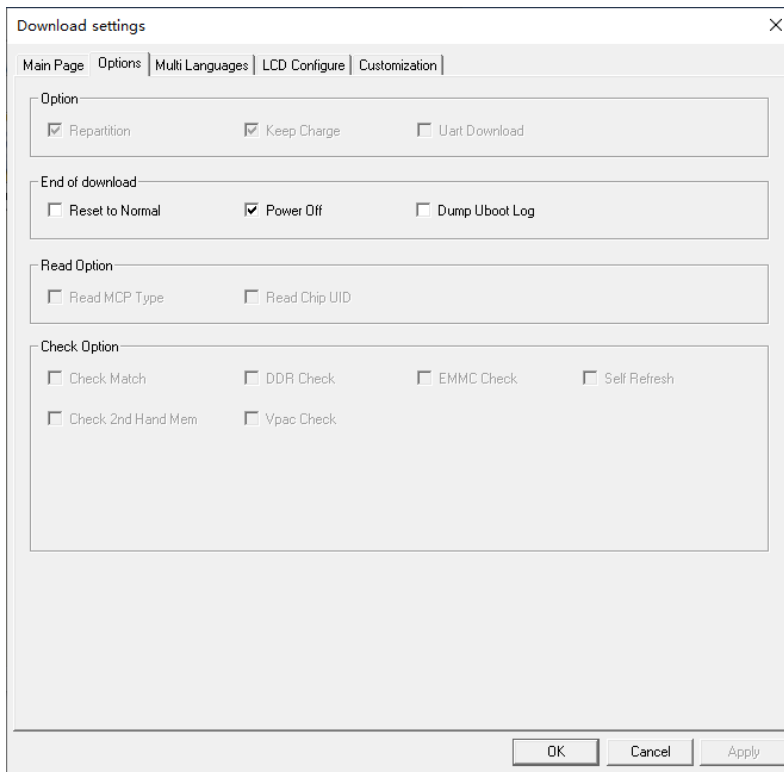
Figure 3-2 FactoryDownload Options

Table 3-2 Description of FactoryDownload Options

Item name	Description
Repartition	It is selected by default and indicates whether to repartition during download, which is valid only for Nand or EMMC Flash products.
Keep Charge	It is unavailable by default and indicates whether to enable charging during download, which requires software support.
Uart Download	It is unavailable by default and indicates whether to download over the serial port.
Reset to Normal	It is cleared by default. It indicates that the tool sends a command to restart the mobile phone in the last step of download.
Power Off	It is selected by default and indicates that the tool sends a command to shut down the mobile phone, which takes effect after unplugging the USB. This function requires software support, and it needs to be selected for built-in battery download.
Dump Uboot Log	It is not commonly used and requires the software support of FDL2. If the download fails, the tool saves the log in Uboot.
Read MCP Type	It is unavailable by default and requires software support.
Read Chip UID	It is unavailable by default and requires software support.
Check Match	It is unavailable by default and requires software support.
DDR Check	It is unavailable by default and requires software support.

Item name	Description
EMMC Check	It is unavailable by default and requires software support.
Self Refresh	It is unavailable by default and requires software support.
Check 2nd Hand Mem	It is unavailable by default and requires software support.
Vpac Check	It is unavailable by default and requires software support.

3.1.3 Multi Languages

Multi Languages is used to set multiple languages in NV. If the NV files selected on Main Page does not contain multilingual information, the interface is empty. Selecting a language indicates that the mobile phone's Man Machine Interface (MMI) enables functions in this language.

3.1.4 LCD Configure

LCD Configure is used to configure LCD-related drivers in PS or UserImg files.

NOTE

Only when the downloaded file list contains PS or UserImg file, LCD-related configuration information is displayed on LCD Configure.

3.1.5 Customization

As shown in [Figure 3-3](#), select **Customization**, and enter Customization.

Figure 3-3 FactoryDownload Customization

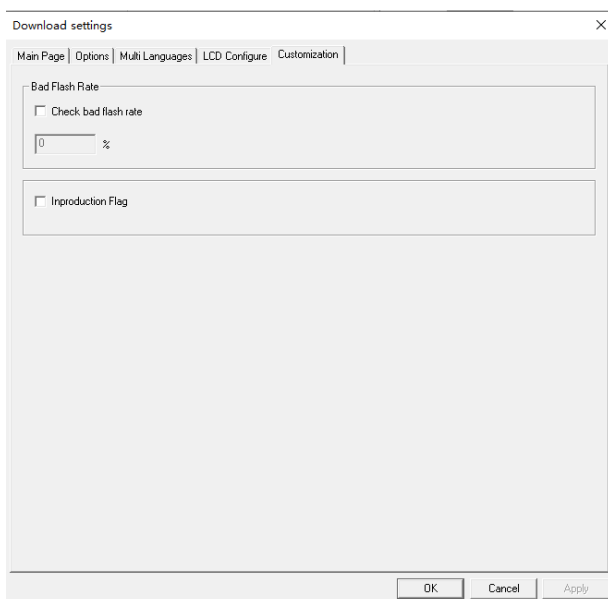

Bad Flash Rate

Select **Check bad flash rate** to set the maximum allowable value of bad flash rate. Enable FactoryDownload to check the Flash bad flash rate of the mobile phone that is waiting for software download (only supports Nand Flash bad flash rate checking currently).

The precondition of enabling the Flash bad flash rate checking function: The software of the mobile phone that is waiting for software download has the function of checking the bad flash rate of Flash.

After enabling the function, FactoryDownload checks the bad flash rate of the mobile phone's Nand Flash before download. When the bad flash rate exceeds the maximum allowable value, the download is cancelled.

Inroduction Flag

The Inroduction Flag function is used infrequently. It is to write in the specified content, and then back them up to the mobile phone when backing up Miscdata partition.

3.2 Operating instruction

Before download, set up the download environment according to [1.3 Download environment setup](#).

3.2.1 Load a file

Open the download tool and click  to load a file that requires download.

3.2.2 Set download parameters

After the file is loaded successfully, click  to enter the setting interface, and set download parameters on Main Page and Options.

- Set the port and Baud rate on Main Page. If you need to input SN manually, select **Input SN**.
- Check **Reset to Normal** or **Power Off** option according to the test requirements on Options.

NOTE

- To set download parameters for mobile phone with built-in battery, it is recommended to select **Reset to Normal** or **Power Off** option.
- The precondition of checking **Power Off**: The mobile software supports the Power Off function after the download is completed.

3.2.3 Start download

1. After the tool is set, click  on Tool bar. The program automatically detects available ports and prepares to download.
2. Set up the test environment, and trigger the download mode of mobile phone. The tool automatically detects the available ports and starts the download, as shown in [Figure 3-4](#).

Figure 3-4 FactoryDownload in download status

Port	Step	Status	Progress	Time[s]
10	FDL	Downloading...		5

If **Input SN** is selected, the dialogue box prompts after FDL file is downloaded, as shown in [Figure 3-5](#). Input SN and click **OK**, the tool will continue to download.

Figure 3-5 FactoryDownload Input SN input box

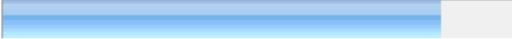
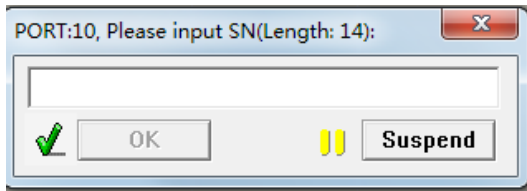

If you click **Suspend** in [Figure 3-5](#), the tool suspends download as shown in [Figure 3-6](#). Click  in [Figure 3-6](#) to resume downloading.

Figure 3-6 Suspend FactoryDownload download

Port	Step	Status	Progress	Time[s]
10	FDL2	 Downloading...		19

3.2.4 Complete download

If the download succeeds and the module is connected, a green **Passed** is displayed on Tool bar, as shown in [Figure 3-7](#).

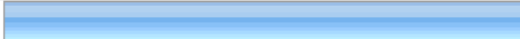
Figure 3-7 FactoryDownload download completed

Port	Step	Status	Progress	Time[s]
10	UBOOTLoader	Finish	Passed	146s

If the download succeeds and the module is disconnected, a blue **Ready** is displayed on Tool bar, as shown in [Figure 3-8](#). If you need to download again, replace the module and enter the download mode, the tool



automatically starts the download without clicking  in Tool bar again.

Figure 3-8 FactoryDownload waits for download again

Port	Step	Status	Progress	Time[s]
10	UBOOTLoader	Unplugged	Ready	121s

3.2.5 Exit download

If FactoryDownload is in automatic download status, other buttons on Toolbar are unavailable. Click  to exit the automatic download status. In this case, other buttons on Toolbar are available. You can click  to reload other files or close the tool directly.

4 UpgradeDownload user guide

UpgradeDownload is applicable for software upgrade in PCBA stage or complete machine stage of mobile phone. The main feature of the tool is the compulsive backup for NV parameters (read back and then write in the mobile phone). It does not operate the PhaseCheck and ProdNV partitions. Before upgrading, the tool checks the calibration flag bit. If the calibration fails, the upgrade cannot be performed.

4.1 Download settings

Click  to enter the setting interface of UpgradeDownload, as shown in [Figure 4-1](#). The interface contains five tabs: Main Page, Options, Multi Languages, LCD Configure, and Customization.

Figure 4-1 UpgradeDownload Main Page

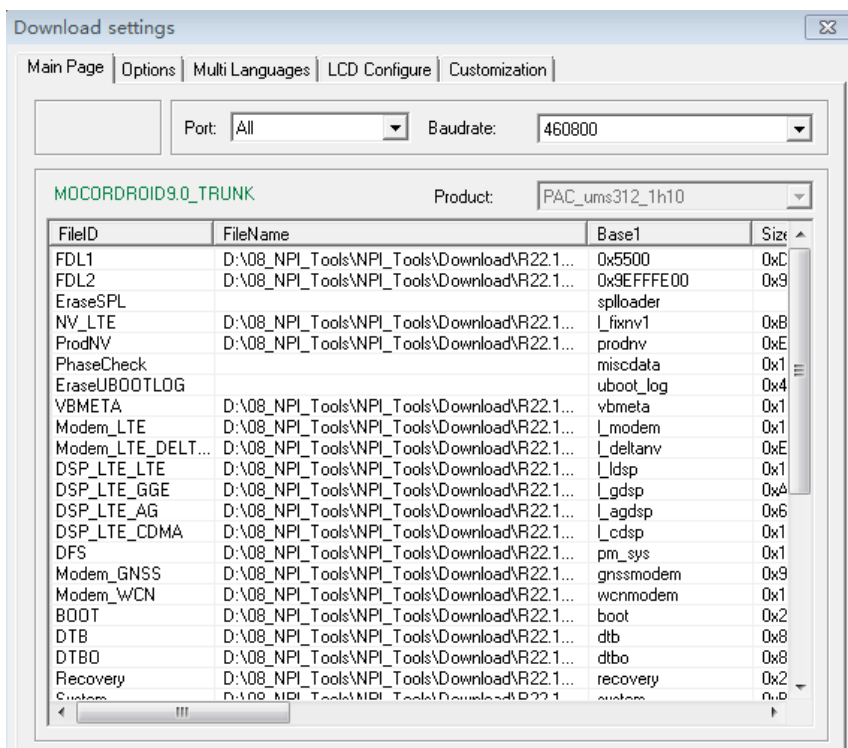

4.1.1 Main Page

As shown in [Figure 4-1](#), Main Page is used to configure the port and its baud rate and display information including downloaded file version and Product. For more details, see [Table 4-1](#).

Table 4-1 Description of UpgradeDownload Main Page

Item name	Description
Port	Port setting. You can select a certain port to download or select All . When selecting All , the tool automatically detects available ports for download. A module corresponds to an available port. When downloading a software for multiple modules simultaneously, there are multiple available ports.
Baudrate	Baud rate setting.
Information bar	Displays version and Product information above the file list.
Downloaded file list	<ul style="list-style-type: none"> • FileID indicates the name of downloaded file. • FileName displays the path to download the file. • Base1 indicates the download address. • Size1 indicates the file size (0x0 indicates that the file size is automatically calculated by the download tool during download).

4.1.2 Options

Options interface requires the support of FDL or Uboot module. As shown in [Figure 4-2](#), only **Reset to Normal**, **PowerOff** (selected by default) and **Dump Uboot Log** can be selected. Other options can be implemented only by modifying the configurations in UpgradeDownload.ini.

Figure 4-2 UpgradeDownload Options

Table 4-2 Description of UpgradeDownload Options

Item name	Description
Repartition	It is selected by default and indicates whether to repartition during download, which is valid only for Nand or EMMC Flash products.
Keep Charge	It is unavailable by default and indicates whether to enable charging during download, which requires software support.
Uart Download	It is unavailable by default and indicates whether to download over the serial port.
Reset to Normal	It is cleared by default. It indicates that the tool sends a command to restart the mobile phone in the last step of download.
Power Off	It is selected by default and indicates that the tool sends a command to shut down the mobile phone, which takes effect after unplugging the USB. This function requires software support, and it needs to be selected for built-in battery download.
Dump Uboot Log	It is not commonly used. It requires the software support of FDL2. If the download fails, the tool saves the log in Uboot.
Read MCP Type	It is unavailable by default and requires software support.
Read Chip UID	It is unavailable by default and requires software support.
Check Match	It is unavailable by default and requires software support.
DDR Check	It is unavailable by default and requires software support.
EMMC Check	It is unavailable by default and requires software support.
Self Refresh	It is unavailable by default and requires software support.
Check 2nd Hand Mem	It is unavailable by default and requires software support.

4.1.3 Multi Languages

Multi Languages is used to set multiple languages in NV. If the NV file selected on Main Page does not contain multilingual information, the interface is empty. Selecting a language indicates that the mobile phone's MMI enables functions in this language.

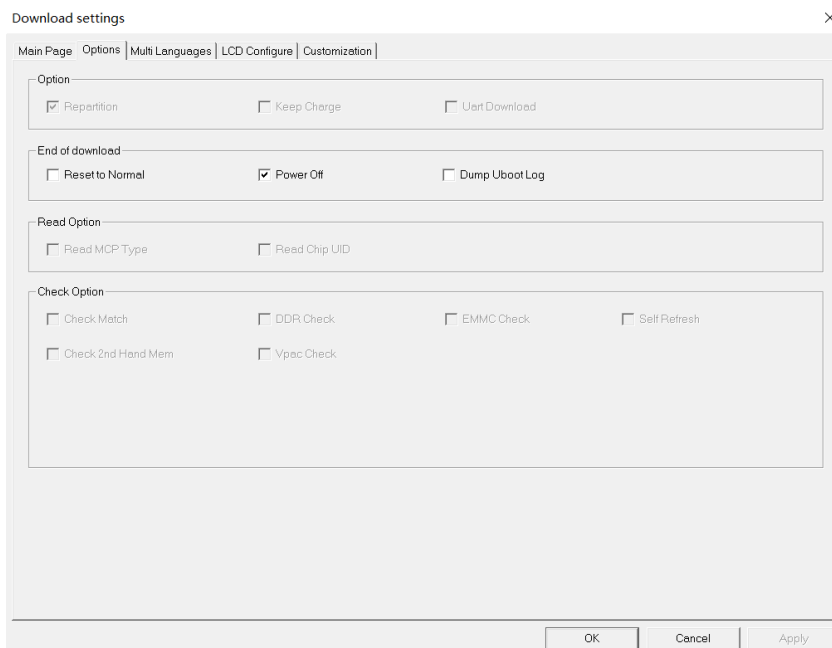
4.1.4 LCD Configure

LCD Configure is used to configure LCD-related drivers in PS or UserImg files.

NOTE

Only when the downloaded file list contains PS or UserImg file, LCD-related configuration information is displayed on LCD Configure.

4.1.5 Customization

As shown in [Figure 4-3](#), select **Customization**, and enter Customization.

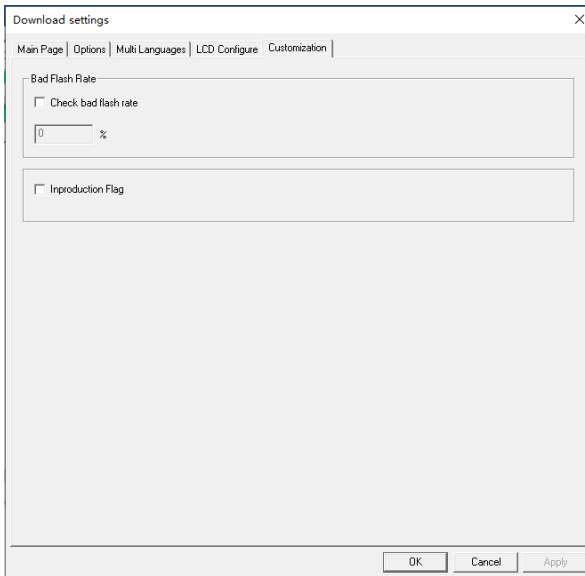
Figure 4-3 UpgradeDownload Customization

Bad Flash Rate

Select Check bad flash rate to set the maximum allowable value of bad flash rate. Enable UpgradeDownload to check the Flash bad flash rate of the mobile phone that is waiting for software download (only supports Nand Flash bad flash rate checking currently).

The precondition of enabling the Flash bad flash rate checking function: The software of the mobile phone that is waiting for software download has the function of checking the bad flash rate of Flash.

After enabling the function, UpgradeDownload checks the bad flash rate of the mobile phone's Nand Flash before downloading. When the bad flash rate exceeds the maximum allowable value, the download is cancelled.

Inroduction Flag

The Inroduction Flag function is used infrequently. It is to write in the specified content, and then back them up to the mobile phone when backing up Miscdata partition.

4.2 Operating instruction

Before downloading, set up the download environment according to [1.3 Download environment setup](#).

4.2.1 Load a file

Open the download tool and click  to load the file that requires downloading.

4.2.2 Set download parameters

After the file is loaded successfully, click  to enter the setting interface, and set download parameters on Main Page and Options.

- Set the port and baud rate on Main Page.
- Check **Reset to Normal** or **Power Off** option according to the test requirements on Options.

NOTE

- To set download parameters for mobile phone with built-in battery, it is recommended to select **Reset to Normal** or **Power Off** option.
- The precondition of selecting **Power Off**: The mobile software supports the Power Off function after the download is completed.

4.2.3 Start download

1. After the tool is set, click  on Tool bar. The program automatically detects available ports and prepares to download.
2. Set up the test environment, and trigger the download mode of the mobile phone. The tool automatically detects the available ports and starts the download.

Figure 4-4 UpgradeDownload in download status

Port	Step	Status	Progress	Time[s]
10	FDL	Downloading...		5

4.2.4 Complete download

If the download succeeds and the module is connected, a green **Passed** is displayed on Tool bar, as shown in [Figure 4-5](#).

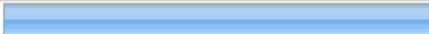
Figure 4-5 UpgradeDownload download completed

Port	Step	Status	Progress	Time[s]
10	UBOOTLoader	Finish	Passed	146s



If the download succeeds and the module is disconnected, a blue **Ready** is displayed on Tool bar, as shown in [Figure 4-6](#). If you need to download again, replace the module and enter the download mode, and the tool automatically starts the download without clicking  in Tool bar again.

Figure 4-6 UpgradeDownload waits for download again

Port	Step	Status	Progress	Time[s]
10	UBOOTLoader	Unplugged	Ready	121s

4.2.5 Exit download

If UpgradeDownload is in automatic download status, other buttons on Toolbar are unavailable, click  to exit the automatic download status. In this case, other buttons on Toolbar are available. You can click  to reload other files or close the tool directly.

5 ResearchDownload user guide

ReserchDownload is mainly used for R&D debugging. It can read and write Flash partition, backup NV parameters, PhaseCheck, and ProdNV partitions (read back and then write in the mobile phone), and package downloaded files. This tool does not initialize ProdNV and PhaseCheck partitions by default, and it is not recommended to be used as a production testing tool.

5.1 Download settings

The setting window is used to set the download process, including the port rate and the files to be downloaded.

Click  on Tool bar to enter the tool setting interface.

5.1.1 Main Page

Main Page is used for port selection, baud rate configuration, file download selection, Product information selection, and file download path customization, as shown in [Figure 5-1](#).

Figure 5-1 ResearchDownload Main Page

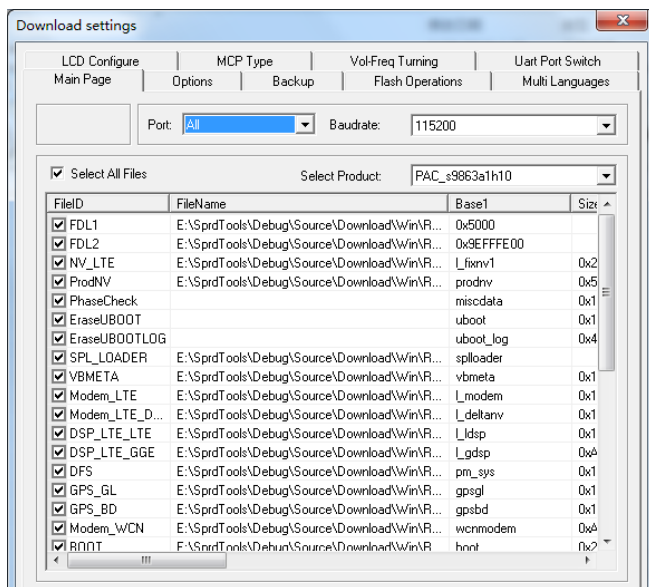
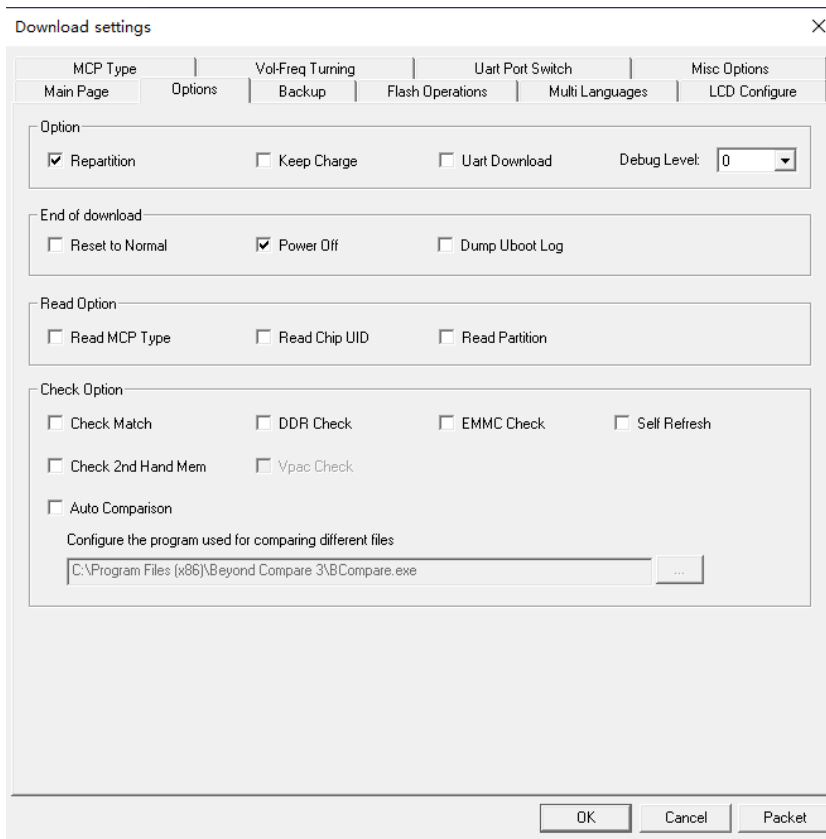

Table 5-1 Description of ResearchDownload Main Page

Item name	Description
Port	Port setting. You can select a certain port to download or select All . When selecting All , the tool automatically detects available ports for downloading. A module corresponds to an available port. When downloading a software for multiple modules simultaneously, there are multiple available ports.
Baudrate	Baud rate setting.
Information bar	Displays version and Product information above the file list.
Downloaded file list	<ul style="list-style-type: none">• FileID indicates the name of downloaded file.• The FileName column is an editable item. After double-clicking, you can enter the file path or open the file selection dialog box to select the file.• Base1 indicates the logical address or partition name of the downloaded partition.• Size1 indicates the size of the downloaded partition. If it is displayed as 0xFFFFFFFF, the partition is an adaptive size.

5.1.2 Options

As shown in [Figure 5-2](#), options interface requires the support of FDL or Uboot module.

Figure 5-2 ResearchDownload Options

Table 5-2 Description of ResearchDownload Options

Item name	Description
Repartition	It is selected by default and indicates whether to repartition during download, which is valid only for Nand or EMMC Flash products. Clear this item to ensure the integrity of mobile phone content when reading Flash.
Keep Charge	It is unavailable by default and indicates whether to enable charging during download, which requires software support.
Uart Download	It is unavailable by default and indicates whether to download over the serial port. Download by using USB if cleared.
Debug Level	It is used to enable or disable the kernel log and requires the support of FDL2. <ul style="list-style-type: none"> The default value is 0: disable the kernel log and select PhaseCheck on Main Page to download. Enable the kernel log: set the kernel log level to 7 in general settings to capture the most complete log.
Reset to Normal	It is cleared by default. It indicates that the tool sends a command to restart the mobile phone in the last step of download.
Power Off	It is selected by default and indicates that the tool sends a command to shut down the mobile phone, which takes effect after unplugging the USB. This function requires software support, and it needs to be selected for built-in battery download.

Item name	Description
Dump Uboot Log	It is not commonly used and requires the software support of FDL2. If the download fails, the tool saves the log in Uboot.
Read MCP Type	It is cleared by default. It requires software support for reading the MCP Type (Flash size) information.
Read Chip UID	It is cleared by default. It requires software support for downloading UID functions for reading.
Check Match	It is cleared by default. It requires the support of customized FDL2 for version fool-proofing.
DDR Check	It is cleared by default. It requires the software support of FDL1 for checking DDR.
EMMC Check	It is cleared by default. It requires the software support of FDL2 for checking the download integrity under EMMC.
Self Refresh	It is cleared by default. It requires the software support of FDL1 for self-refreshing.
Check 2nd Hand Mem	It is cleared by default. It requires software support for checking second hand memory.
Auto Comparison	It automatically compares the read-back partition data with the original data of the corresponding partition in Pac, which needs to be used with the Read Flash function in Flash Operations. If a third-party comparison software is configured, it is called at the same time to implement the comparison function.

5.1.3 Backup

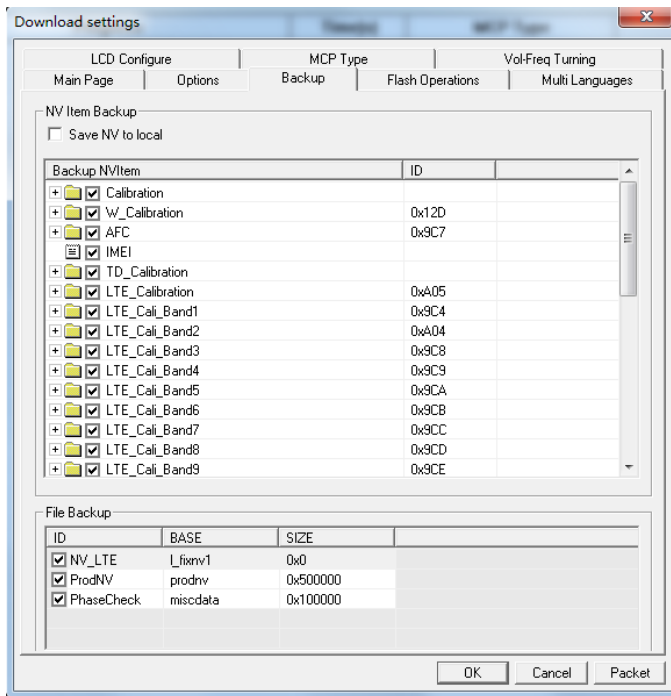
As shown in [Figure 5-3](#), Backup is used for setting the items to be backed up for download. During download, you can choose whether to backup NV, ProdNV, and PhaseCheck based on actual need.

Figure 5-3 ResearchDownload Backup

Backup NV Item

Backup NVItem lists NV ID items to be backed up. For example, if the backup NV is set in **File Backup**, you can first read the NV in the mobile phone back to the PC, backup the IDs one by one according to the selected NV ID items in **Backup NVItem**, and then download them to the mobile phone. These backup items are only valid for NV partition. If a non-NV item is selected in **File Backup**, the configuration information of the backup item is not displayed on the interface.

Save NV to local

For example, if **Save NV to local** is selected and the backup function is set in **File Backup**, the backup partition file that is named after the SN information is saved in the Backup directory under the tool directory after downloading.

File Backup

The **File Backup** list box lists the partitions that need to be backed up by default. The partitions are backed up if the item is selected. If not selected, the partitions are not backed up and the original download files in Pac are directly downloaded to the corresponding partition. If the corresponding download item is not selected on the setting interface of Main Page, these partitions are not operated during download.

NOTE

Each time you reopen the download program, the above options in **5.1.3 Backup** are restored to default values.

5.1.4 Flash Operations

As shown in [Figure 5-4](#), Flash Operations is used to control the functions of Flash reading and erasing. The configuration items on Flash Operations are processed only after download items on Main Page are processed.

Figure 5-4 ResearchDownload Flash Operations

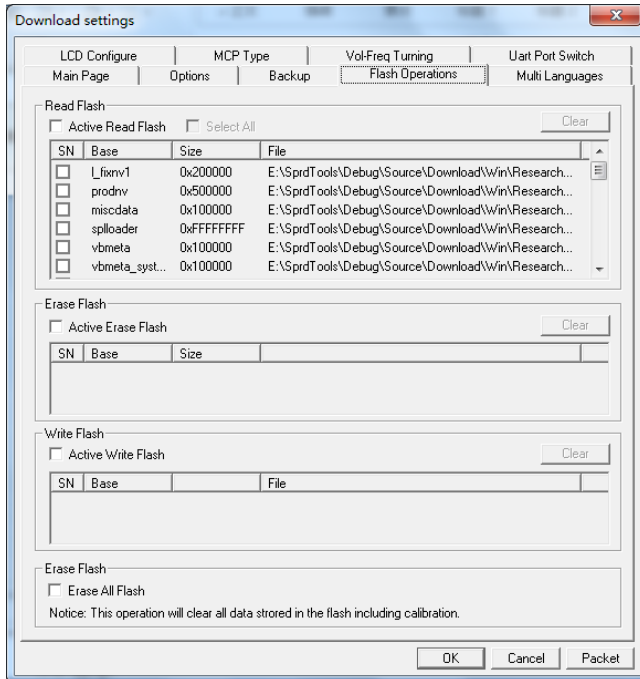

Read Flash

This function is used to read partition data from the Flash of a mobile phone and save it to a file on PC.

- After the Pac file is loaded, the tool automatically generates the default read back configurations based on the download items in Pac.
- Select **Active Read Flash**, and select the read-back configuration item of the partition to be read, then customize the **Base**, **Size**, and **File** of the partition to be read. For details about the configuration information, see [Table 5-3](#).
- To ensure the integrity of read-back data, do not select **Repartition** on Options if you only need to read back the content of Flash partition.

Table 5-3 Read Flash configuration item

Item name	Description
SN	It is used to select or cancel a specified read-back configuration item.
Base	The information about the Base or ID of the read-back partition is the same as Base1 bar on Main Page.
Size	It indicates the size (Byte) of the partition to be read back, which must be smaller than or equal to the size of the entire partition. The hexadecimal value starts with 0x.

Item name	Description
File	It is used to save the contents of read-back partition to the local file path.
Active Read Flash	It indicates the switch of read-back function, which needs to be selected to operate the contents in the list.
Select All	It is used to select or cancel all read-back configuration items
Clear	It is used to clear the configuration of all read-back configuration items.

Erase Flash

This function is used to erase a download partition. After selecting **Active Erase Flash**, you can configure the partition information to be erased. For details about the configuration items, see [Table 5-4](#).

Table 5-4 Erase Flash configuration item

Item name	Description
SN	It is used to select or cancel a specified Erase Flash configuration item.
Base	The information about the Base or ID of the parts to be erased in the partition is the same as Base1 bar on Main Page.
Size	It indicates the size (Byte) of the partition to be erased, which must be smaller than or equal to the size of the entire partition. The hexadecimal value starts with 0x. Erase the entire partition if Size is 0.
Active Erase Flash	It indicates the switch of Erase Flash, which needs to be selected to operate the contents in the list.
Clear	It is used to clear the configuration of all Erase Flash configuration items.

Write Flash

This function is used to write a specified download file to a download partition, which is same as the function of the download item on Main Page. After selecting **Active Write Flash**, you can configure the partition information that needs to be written to. For details about the configuration items, see [Table 5-5](#).

Table 5-5 Write Flash configuration item

Item name	Description
SN	It is used to select or cancel a specified Write Flash configuration item.
Base	The information about the Base or ID of the Flash partition that needs to write a specified file is the same as Base1 bar on Main Page.
File	It indicates the local file path that needs to write in the Flash partition.
Active Erase Flash	It indicates the switch of Write Flash, which needs to be selected to operate the contents in the list.

Item name	Description
Clear	It is used to clear the configuration of all Write Flash configuration items.

Erase All Flash

Select **Erase All Flash** if you need to erase the entire Flash. If **Erase All Flash** is configured, this tool firstly reads back the backup partition and erases the entire Flash, then completes the download items on Main Page, and finally executes the reading, writing and erasing configuration items in the setting.

CAUTION

Not all products support **Erase All Flash**.

5.1.5 Multi Languages

Multi Languages is used to set multiple languages in NV. If the NV file selected on Main Page does not contain multilingual information, the interface is empty. Selecting a language indicates that the mobile phone's MMI enables functions in this language.

5.1.6 LCD Configure

LCD Configure is used to configure LCD-related drivers in PS or UserImg files.

NOTE

Only when the downloaded file list contains PS or UserImg file, LCD-related configuration information is displayed on LCD Configure.

5.1.7 MCP Type

As shown in [Figure 5-5](#), select **MCP Type** on the setting interface to enter MCP Type.

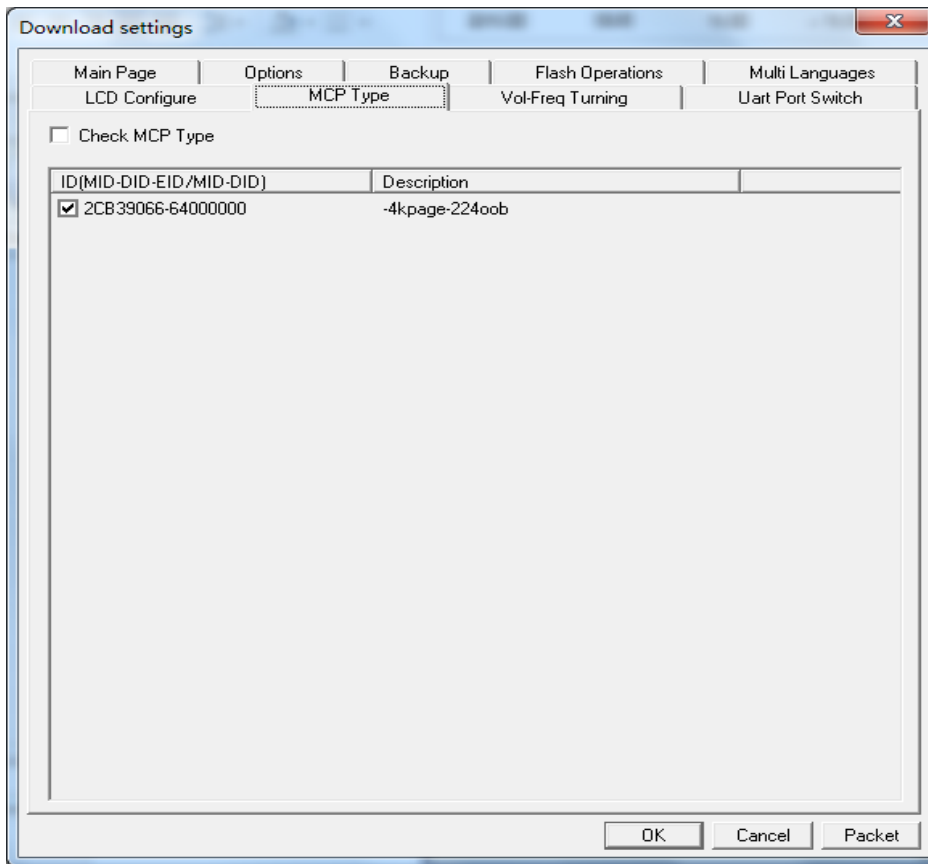
Figure 5-5 ResearchDownload MCP Type

Select **Check MCP Type** and the tool checks whether MCP Type matches the selected item after downloading FDL1 (FDL2). If the match fails, an error is reported. MCP Type is set in the configuration file MCPTType.ini. If you want to add MCP Type, add it in this file.

5.1.8 Vol-Freq Tuning

As shown in [Figure 5-6](#), Vol-Freq Tuning is used to set voltage and frequency.

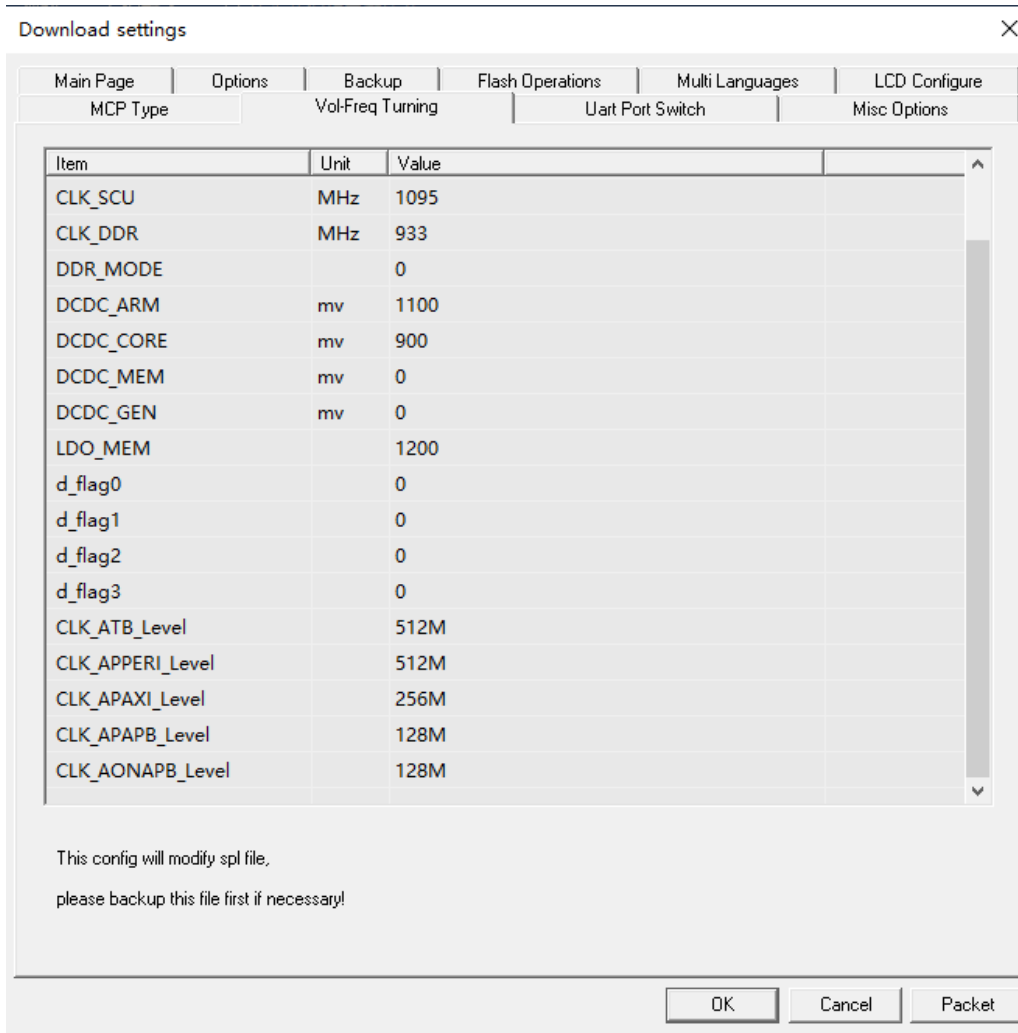
Figure 5-6 ResearchDownload Vol-Freq Tuning

On Download settings, select **Vol-Freq Tuning** to enter the Vol-Freq Tuning. Double-click the **Value** column to set the voltage or frequency and the setting results are directly saved to the SPLLoader file. Therefore, it is recommended to backup this file before changing the settings. Whether the Vol-Freq Tuning can be modified depends on the special tags in the SPLLoader file. If no special tags or SPLLoader download items are available, the Vol-Freq Tuning cannot be modified. The rendering of detailed interface depends on the data format of the tag block.

5.1.9 Uart Port Switch

As shown in [Figure 5-7](#), Uart Port Switch is used to configure Uart ports.

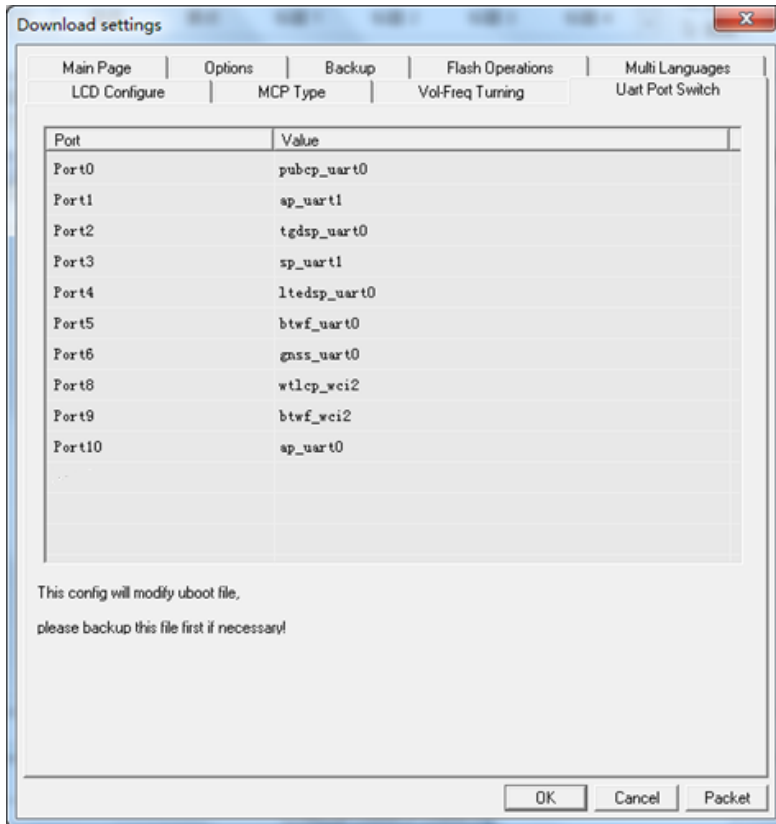
Figure 5-7 ResearchDownload Uart Port Switch

On Download settings, select **Uart Port Switch** to enter the Uart Port Switch. Double-click the **Value** column to modify related parameters, which are directly saved to the UBOOTLoader file. Therefore, it is recommended to backup this file before modifying. Whether the Uart Port Switch can be modified depends on the special tags in the UBOOTLoader file. If no special tags or UBOOTLoader download items are available, this interface cannot be modified.

5.2 Operating instruction

Before downloading, set up the download environment according to [1.3 Download environment setup](#).

5.2.1 Load a file

Open the download tool and click  to load the file that requires downloading.

5.2.2 Set download parameters

After the file is loaded successfully, click  to enter the setting interface, and set download parameters.

- Main Page: set the port and baudrate and select the file that requires downloading.
- Options: select **KeepCharge**, **Reset to Normal** or **Power Off** option according to the test requirements.
- Backup: set whether to back up NV, PhaseCheck, and ProdNV item.

 **NOTE**

- FDL1 is compulsory when selecting download files (FDL2 is also compulsory if exists). Select other files based on requirements.
- To set download parameters for mobile phone with built-in battery, it is recommended to select **Reset to Normal** or **Power Off** option.
- The precondition of selecting **Power Off**: The mobile software supports the Power Off function after the download is completed.

5.2.3 Start download

1. After the tool is set, click  on Tool bar. The program automatically detects available ports and prepares to download.
2. Set up the test environment, and trigger the download mode of mobile phone. The tool automatically detects the available ports and starts the download, as shown in [Figure 5-8](#).

Figure 5-8 ResearchDownload in download status

Port	Step	Status	Progress	Time[s]
10	FDL	Downloading...		5

5.2.4 Complete download

If the download succeeds, a green **Passed** is displayed on Tool bar, as shown in [Figure 5-9](#).

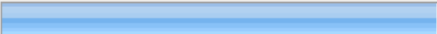
Figure 5-9 ResearchDownload download completed

Port	Step	Status	Progress	Time[s]
10	UBOOTLoader	Finish	Passed	146s

If the module is disconnected, a blue **Ready** is displayed on Tool bar, as shown in [Figure 5-10](#). If you need to download again, replace the module and enter the download mode, the tool automatically starts the download



without clicking  again.

Figure 5-10 ResearchDownload waits for download again

Port	Step	Status	Progress	Time[s]
10	UBOOTLoader	Unplugged	Ready	121s

5.2.5 Exit download

If ResearchDownload is in automatic download status, other buttons on Toolbar are unavailable, click  to exit the automatic download status. In this case, other buttons on Toolbar are available. You can click  to reload other files or close the tool directly.

6 Command line download

FactoryDownload, UpgradeDownload and ResearchDownload not only support the graphical interface download described previously, but also command line download. Command line download is implemented by CmdDloader application, and the whole download process is handled in the background. The CmdDloader application is responsible for starting the download tools and monitoring the download progress and results.

6.1 Parameter format

The parameter format for the command line to start the CmdDloader application is as follows.

```
CmdDloader.exe <-pac PacFile> [-port ComPort] [-c] [-WriteSN SN1] [-WriteSN2 SN2] [-timeout t][[-cout n]
```

For example,

```
CmdDloader.exe -pac D:\SC7702_sc7701.pac -port 195
```

NOTE

- -pac PacFile: enter the Pac file.
- -port ComPort: enter the port number of download devices.
- -c: this command is optional. When you enter this parameter, the CmdDloader application clears the download progress before executing the download.
- -WriteSN XXXXXX and -WriteSN2 YYYYYY: these two parameters are used only when FactoryDownload_Cmd writes SN number.
- -timeout xx: the unit is in seconds. The timeout in waiting for port connection ends the download process. This parameter is not commonly used.
- -count x: number of modules in simultaneous software download without entering the port number. This parameter is not commonly used.
- If no port information is specified, the application automatically searches for an appropriate port for downloading. The configuration item WaitDUTTimeout in CmdDloader.ini sets the time to wait to find a valid device. When the value is 0, it indicates an infinite wait until an appropriate download port is found.

6.2 Download example

Figure 6-1 shows an example of successful command line download, and **Download Passed** indicates the download succeeds.

Figure 6-1 Successful CmdDloader download

```

E:\SprdToolSpace\Debug\Source\Download\Win\ResearchDownload\Bin>CmdDloader.exe
pac D:\SC7702_sc7701_128X160BAR_32MB_384K_B3.pac -port 195
||*****||
Pac : D:\SC7702_sc7701_128X160BAR_32MB_384K_B3.pac
Port : 195
||*****||
Successfully connected to Dloader.

Loading pac file ...
Load PAC file successfully!
Detecting download device [COM195] ...
Waiting
FDL      Checking baudrate
FDL      Connecting
FDL      Downloading...          <100%>
FDL      Checking baudrate
FDL      Connecting
FDL      Change Baud
FDL2     Downloading...          <100%>
_BKF_MU  Reading Flash             <100%>
NU       Downloading...          <100%>
BootLoader Downloading...        <100%>
UserImg  Downloading...          <100%>
MMIRes   Downloading...          <100%>
DSPCode  Downloading...          <100%>
DSPCode2 Downloading...          <100%>
FLASH    Erasing flash
KernelImg Downloading...          <100%>
Erase FS Erasing flash
Download Passed, Elapsed Times = 34s
    
```

Figure 6-2 shows an example of failed command line download, and displays the error message for failed download.

Figure 6-2 Failed CmdDloader download

```

||*****||
Pac : D:\SC7702_sc7701_128X160BAR_32MB_384K_B3.pac
Port : 195
||*****||
Successfully connected to Dloader.

Loading pac file ...
Load PAC file successfully!
Detecting download device [COM195] ...
Waiting
FDL      Checking baudrate
FDL      Connecting
FDL      Downloading...          <100%>
FDL      Checking baudrate
FDL      Connecting
FDL      Change Baud
FDL2     Downloading...          <100%>
_BKF_MU  Reading Flash             <100%>
NU       Downloading...          <100%>
BootLoader Downloading...        <100%>
UserImg  Downloading...          <100%>
MMIRes   Downloading...          <100%>
[ERROR] Download Failed: User cancel, Elapsed Times = 18s
    
```

7 Interface error message analysis and solution

This chapter describes the causes of interface error message and corresponding solutions.

7.1 [DL1150] Incompatible partition

Cause

- The partition table in XML or FDL2 is incompatible with the partition on Flash.
- The partition does not exist or is damaged.

Solution

1. Check **Options** on the setting interface and select **Repartition**.
2. Check whether the File list corresponds to the partition table in the software XML.
3. Check FLASH Hardware.
4. If Nand project is second hand memory, it needs to be all erased to download.
5. Check software according to log.

7.2 [UB1142] Wait input time out

Cause

The device-side response returns timeout.

Solution

Provide tool log ([Table 2-1](#) describes how to set tool log.) and serial port log for Uboot-side analysis.

7.3 [DL1138] Image size is over its partition

Cause

The size of downloaded Image file is inconsistent with the partition size of the mobile phone.

Solution

1. Check whether Pac corresponds to the mobile phone and check whether the XML configuration is consistent with the actual partition size of the mobile phone.
2. Modify the partition size or modify the XML definition about the partition size in the product Pac to make it consistent.

For example,

If an error is reported after using Read FixNV to write back again, you can find the solutions in [8.17 Prompt message \(Size is too large\) occurs when ResearchDownload reads FixNV write-back](#).

7.4 [PS2262] User cancel

Cause

- The device is unplugged manually.
- The device is unplugged due to environmental causes, such as poor contact.
- The port enumeration on UE-side is stopped

Solution

- The problems that are not sure to come may be associated with environment, which can troubleshoot the mismatches between USB cables, computer USB ports, battery capacity, or Pac with the devices.
- The problems that are sure to come need to provide Uboot software colleagues with serial port log to analyze and solve the specific problems.

7.5 [UB1254] Software has not supported this feature

Cause

The software does not support the command.

Solution

Provide tool log ([Table 2-1](#) describes how to set tool log.) for Uboot-side analysis and add corresponding command support.

7.6 [PS2257] Uart send error

Cause

The possible causes that the data cannot be written on the port during download:

- If the FDL1 download has not started, the hardware and download environment need to be checked.
- If the FDL1 download has finished, FDL1 is not running or DDR fails to initialize.

Solution

- The problems that are not sure to come may be associated with environment, which can troubleshoot the mismatches between USB cables, computer USB ports, battery capacity, or Pac with the devices.
- The problems that are sure to come need to provide Uboot engineers with serial port log to analyze and solve the specific problems.

7.7 [UB1132] Operation failed

Cause

The Uboot-side returns the response of Operation fails.

Solution

Provide tool log (Table 2-1 describes how to set tool log.) and serial port log for Uboot personnel to do recurrence analysis.

7.8 [SW2020] NV data read in phone is crashed

Cause

The end identifier ID = FFFF is not found by the tool due to an NV data structure error within the device.

Solution

- Modify the MaxReadLength field in BMFileType.ini after NV capacity expansion.

```
[DownloadNV]
```

```
MaxReadLength = 0x100000
```

NOTE

The default value of the MaxReadLength field is 0x100000, that is, the maximum length of the NV read by the tool from the device is 1 MB by default.

- Provide read-back NV files and tool log (set the log level to 5) for UNISOC NV personnel to analyze.
The operations about reading the NV files back are as follows.
ResearchDownload → Setting button → only select FDL1 and FDL2 on Main Page → No backup on Backup → Read Fix NV partition back on Flash Operations.

7.9 [SW2021] NV data in nvitem.bin is crashed

Cause

The NV file in Pac is not valid NV data, or the NV file is not 4 Byte aligned.

Solution

Use the Pac file with correct NV file and provide nvitem.bin file for UNISOC NV personnel to analyze.

8 FAQ and supplementary information

8.1 Unrecognize the port

If the module is connected and the device manager can enumerate ports, but the download fails, the possible causes are as follows.

- The power supply to the module is abnormal, for example, there is no external power supply.
- The port is occupied by another application.
- The module is not in the download mode. See [1.4 Entry methods of download mode](#) to ensure the module is under the download mode.

8.2 Fail to capture the port after modifying the port name

After modifying the port name in device manager, you need to modify the [AT_REBOOT_SETTING] part in BMFileType.ini file and add the port name. The added port name must be consistent with the modified port name in device manager.

8.3 Local file has a .flag suffix after decompressing Pac

Cause

To prevent large temporary files after decompression, the download tool has a decompression strategy when decompressing Pac. If the size of the decompressed file is greater than the set value, the compression is not required. Only a temporary file with a .flag suffix is generated, and the data is still saved in Pac.

Solution

Modify the BinPac.ini file by setting LoadPolicy and MaxReadLength in Settings to 0 as follows.

```
[Setting]
LoadPolicy = 0
MaxDataLength = 0 ; the unit is MB
```

NOTE

The modification takes effect only after you restart the download tool.

8.4 Modify required or optional attributes of files in the partition list

In the XML file of Pac, <File> has Flag and CheckFlag definitions, and each downloaded file has corresponding Flag and CheckFlag definitions in the XML file. You can modify the required or optional attributes of the downloaded file by modifying the CheckFlag definition of the downloaded file.

Flag

- 0: You have no need to enter the file path.
- 1: You must enter the file path if 1 is selected.

CheckFlag

- 0: The file is optional.
- 1: The file is required.
- 2: The file is not checked.

8.5 Record ID information of the module

The download tool records the ID information of the module that downloads a software, and saves it as a CSV or TXT file. This function is disabled by default. You can enable this function by modifying the `xxDownload.ini` file. The related fields and descriptions are as follows.

```
[Report]
;report file name is download_result.txt under the tool folder.
enable=0                //function switch, 0: disabled, 1: enabled.
;0, Normal; 1, Press
Type=0                  //saved file type, 0: txt, 1: csv.
;DUTID: 0, IMEI; 1, SN; 2, ChipUID;3, SN_IMEI
DUTID=1                 //type of recorded data, 0 and 3 are only valid for UpgradeDownload and
ResearchDownload.
```

The fields in [Report] in the `xxdownload.ini` file are modified as follows.

- Turn on the switch of recording ID information (set the enable field to 1)
- Specify the format of file saving to save the ID information of downloaded module
 - Type= 0: txt
 - Type= 1: csv
- Specify the ID information type of download module to be recorded
 - 0: IMEI
 - 1: SN
 - 2: ChipUID
 - 3: SN and IMEI

Save the `xxDownload.ini` file and restart the download tool to make the above settings take effect.

8.6 Set tool Log level

There are two ways to set tool log level for effective capture log.

- Modify the Local Log Level field in iSpLog.ini file under the tool installation directory.

```
[Options]
; Text log level
; 0, No text log
; 1, Log errors,default value
; 2, Log warnings
; 3, Log runtime information
; 4, Log data only
; 5, Log everything
Local Log Level = 5
```

This method barely influences the download rate.

- Adjust the tool log level in Status bar at the bottom of the tool interface.

8.7 Check MCP (DDR or EMMC)

ResearchDownload, FactoryDownload and UpgradeDownload all support checking MCP (DDR or EMMC) function.

CAUTION

This function requires the software support of module. If the tool enables this function but the module software does not support it, the download tool stops the download process and display the prompt message of **Software has not supported this feature**.

Set MCP check item

1. Convert the DDR Size and EMMC Size of the device to a hexadecimal number in MB to obtain the MCP check item of the device.

For example, the DDR Size of the device is 4 GB and the EMMC Size is 63 GB. After converting into hexadecimal number, its MCP check item is 1000-FC00 = TEST.

NOTE

The format of device MCP check item is **DDR Size-EMMC Size = Description**, where **DDR Size** is the size of DDR, **EMMC Size** is the size of EMMC (both of them are displayed in hexadecimal number), and **Description** is the name of MCP check item.

2. Modify MCPTYPE.ini to write device MCP check item to the MCPTYPERange field or / and the MCPTYPEList field.
 - Only one MCP check item can be added to the MCPTYPERange field, which is used as the default check item.
 - One or more MCP check items can be added to the MCPTYPEList field, including the default check item of the MCPTYPERange field and other alternative check items. Use ResearchDownload to check MCP check items on MCP Type.

NOTE

To set MCP check item quickly, use the ReadMCP function of ResearchDownload to read back the device's MCP and copy it to the MCPTYPERange field in MCPTYPE.ini.

Enable the MCP checking function of the tool

- ResearchDownload
 - Check **Read MCP Type** on **Option**.
 - Check **Check MCP Type** on **MCP Type**.
- FactoryDownload
 - Modify FactoryDownload.ini, and set the value of the **ShowMcpTypePage** filed to 1.
 - Modify MCPTYPE.ini file, and set the value of the **CheckMCPTYPE** filed to 1.
- UpgradeDownload
 - Modify UpgradeDownload.ini, and set the value of the **ShowMcpTypePage** filed to 1.
 - Modify MCPTYPE.ini file, and set the value of the **CheckMCPTYPE** filed to 1.

After completing the setting of MCP check item and enabling the tool's MCP checking function, the tool checks the MCP according to the setting when downloading.

8.8 Set password for download tool

You can set passwords for both FactoryDownload and UpgradeDownload.

Modify FactoryDownload.ini or UpgradeDownload.ini settings to enable the password mechanism.

[GUI]

NeedPassword=1



After enabling the password mechanism, reopen the download tool. When you click  or , an input box prompts for inputting password, as shown in [Figure 8-1](#).

Figure 8-1 Enter password



Click **Reset** in [Figure 8-1](#), a password reset interface prompts as shown in [Figure 8-2](#). You can reset your password after inputting your new password and inputting it again for confirmation.

Figure 8-2 Reset password

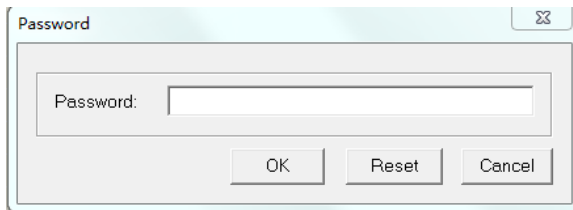
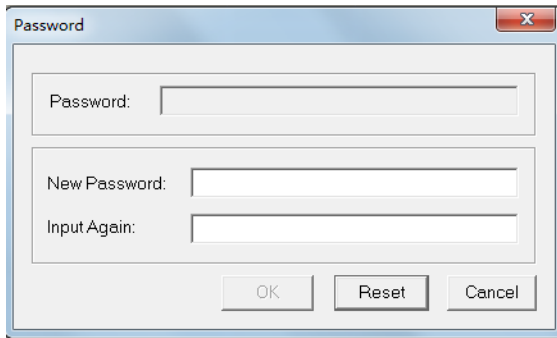
The image shows a standard Windows-style dialog box titled "Password". It contains three text input fields: "Password:", "New Password:", and "Input Again:". Below the fields are three buttons: "OK", "Reset", and "Cancel". The dialog box has a close button (X) in the top right corner.

NOTE

- The initial password is **admin**.
- The password must be letters (a-z, A-Z) or numbers (0-9), which exceeds no more than 20 characters in length.

8.9 Inroduction Flag function

This infrequently used function is on Customization. It is to write in specific contents and backthemup to mobile phone when backing up the Miscdata partition.

8.10 Set the writing length of FactoryDownload SN

When downloading, FactoryDownload writes a SN in mobile phone, whose default length is 14. Modifying the SN_LENGTH field in FactoryDownload.ini can reset the writing length of SN.

```
[SN]  
SN_LENGTH = 14
```

8.11 Set the prefix of the SN written in by FactoryDownload

FactoryDownload.ini can customize the SN prefix written in by FactoryDownload when downloading. The example of a customized SN prefix is as follows.

```
[SN]  
SN_LENGTH = 14  
FixedSN = xxx //xxx indicates the SN prefix, whose length shall not exceed the length of SN.
```

8.12 Set the entry mode of the first booting after FactoryDownload download

The fields and their configurations description in FactoryDownload.ini to set the entry mode of the first booting is shown as follows.

```
[FirstMode]
;Enable: 0:disable; 1:enable
Enable=1
SupportFeaturePhone=0
FirstMode=0x13
;0x00 normal boot mode
;0x01 GSM cal mode
;0x02 GSM Final test mode
;0x03 Wcdma cal mode
;0x04 Wcdma final test mode
;0x05 TDscdma cal mode
;0x06 TDscdma Final test mode
;0x07 LTE TDD cal mode
;0x08 LTE TDD final test mode
;0x09 LTE FDD cal mode
;0x0A LTE FDD final test mode
;0x0B NR 5g sub6g cal mode
;0x0C NR 5g sub6g final test mode
;0x0D NR mmW
;0x0E NR mmW final test mode
;0x0F CDMA2k cal mode
;0x10 CDMA2k final test mode
;0x11 BBAT mode
;0x12 native MMI mode(MMI for feature phone)
;0x13 Apk MMI (apply for smartphone)
;0x14 NB-IOT cal mode
;0x15 NB-IOT final test mode
;0x16 UPT
;0x17--0xFF reserved
```

An example of the setting: entering APK mode of the first booting after the download of smart phone.

1. Modify the related fields of FirstMode in FactoryDownload.ini according to the following settings, and save the settings.
 - Configure the Enable field as 1 (enable switch of the function).

- Reset the SupportFeaturePhone field (unsupported for feature phone).
 - Configure the FirstMode field as 0x13 (first entry of APK mode).
2. Reopen FactoryDownload to download Pac.
 3. Confirm if the mobile phone enters APK mode when booting for the first time after download.
 - If selected **Poweroff** when downloading, the mobile phone is shut down automatically after downloading. Hold the power button for 3 seconds to reboot the mobile phone, and confirm if the mobile phone enters APK mode.
 - If selected **Reset to Normal**, the mobile phone is booted automatically after downloading. Confirm if the mobile phone enters APK mode after the booting.

NOTE

- Download is only used to verify the validity of the settings above. Therefore, select only FDL1, FDL2 and Uboot when setting Main Page to save download time.
- If the mobile phone enters modes including GSM cal mode or BBAT mode, and the Device Manager enumerates ports and does not drop them after booting, send an AT command, such as `AT+GETTESTMODE?`, to check if the current mode is consistent with the one you set.

8.13 Configure Sparse2Raw in FactoryDownload.ini

```
;CheckSparse2Raw 0: not use Sparse2Raw
;CheckSparse2Raw 1: use Sparse2Raw in all partition
;CheckSparse2Raw 2: use Sparse2Raw only in super
;CheckSparse2Raw 3: use Sparse2Raw not in userdata
CheckSparse2Raw = 2
```

There are Sparse download format and Raw download format for files in Pac. Files in Raw format have a faster download rate, so you should try to use the Sparse2Raw application to convert larger files in Pac from Sparse format to Raw format to increase the download rate.

Therefore, setting CheckSparse2Raw field to 2 by default is the optimal plan, and requires no modification for now.

8.14 Upgrade software using UpgradeDownload

UpgradeDownload is indispensable for software upgrade, which forcibly backs up NV, PhaseCheck, and ProdNV information.

8.15 Packet using ResearchDownload

The operation of ResearchDownload to packet is as follows.

Step 1 Click  to load a Packet.

Step 2 Click  to enter Main Page to choose the file that needs to be packeted. Cleared files are not packeted. If you need to replace a file, double-click the **FileName** column of the corresponding to **File ID** to select another file for packeting.

Step 3 Click **Packet**, and a packet setting interface prompts as shown in **Figure 8-3**. Input the product alias, product version and saving path, and click **OK** to start packeting.

Figure 8-3 Packet setting

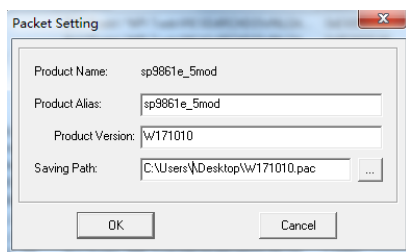

After successful packeting, the message shown in **Figure 8-4** prompts.

Figure 8-4 Packeting complete prompt

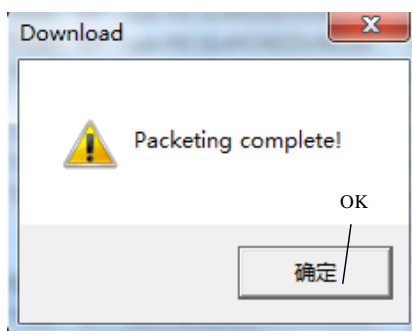

—End

8.16 Erase Flash using ResearchDownload

The operation of ResearchDownload to erase Flash is as follows.

Step 1 Click  on Tool bar to load a Packet.

Step 2 Click  to select **FDL1** and **FDL2** only on Main Page and select **Erash All Flash** on Flash Operations.

NOTE

Do not select other options on this interface. Otherwise, the mobile phone starts downloading other selected files after erasing.

Step 3 Back to the main interface, click , and the following dialogue box prompts as shown in **Figure 8-5**. Click **Yes** to confirm and start erasing.

Figure 8-5 Erase Memory using ResearchDownload

—End

8.17 Prompt message (Size is too large) occurs when ResearchDownload reads FixNV write-back

The FixNV partition configured in the XML configuration in Pac is 2 MB (0x200000), but its actual size is only about 800 KB (can be learned from the nvitem.bin file in Pac), and the remaining 1 MB is used to store Running NV and other content.

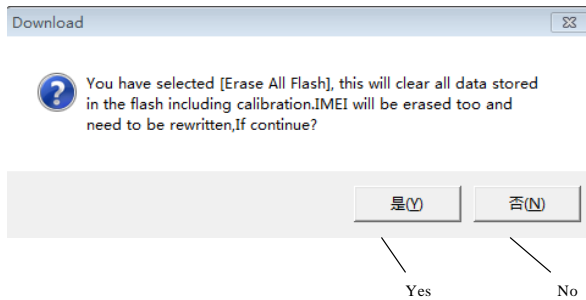
Therefore, when using Active Read Flash to read FixNV, only 1 MB can be read. In other words, only when changing the setting to 0x100000 can the read FixNV be written back to the mobile phone.

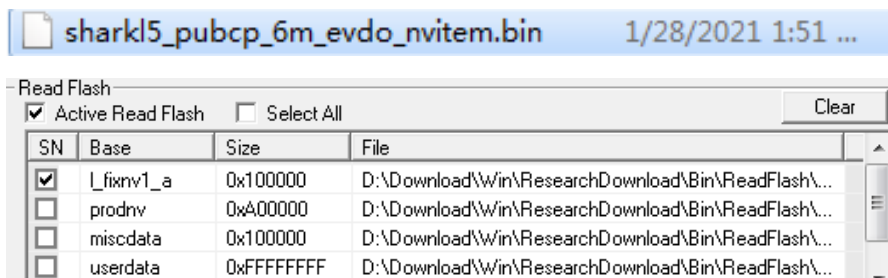

8.18 Set ResearchDownload Debug Level

- If the Debug level set by the device is any level between 0 to 6, ResearchDownload can set the Debug level to any level between 0 to 7.
- If the device has set Debug level to 7, you cannot use ResearchDownload to change Debug level to any level from 0 to 6. The solution is to use the **Erase All Flash** operation to fully erase Flash and then download Pac again, and set the Debug level.

NOTE

Debug level is saved in the Miscdata partition at 9 KB+32 Bytes offset. UpgradeDownload does not operate the Miscdata partition in backup download, so it does not modify the Debug level.